

YAMAHA

STEREO POWER Amplifier

M-4

OWNER'S MANUAL

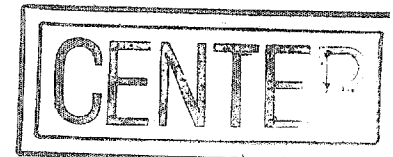
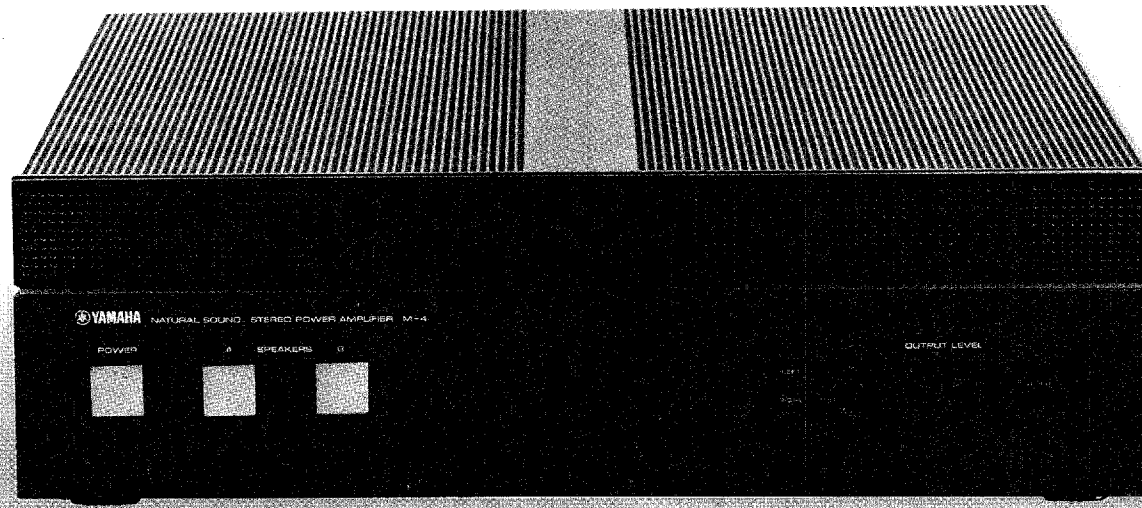

Thank you very much for purchasing the YAMAHA Stereo Power Amplifier M-4. Developed by applying the best of YAMAHA's superior electronic technology, the M-4 is a DC stereo power amplifier that achieves an extremely high level of performance.

The output stage, which uses pure complementary OCL and parallel push-pull circuitry, produces the rated output of 120W + 120W (General and European model) without any strain on the large-capacity power supply section.

Before first operating your M-4, please read this Owner's Manual carefully, in order to fully realize the potential of the unit and to keep it in best condition for many years of trouble-free use.

CONTENTS

FEATURES	2
CAUTION; READ THIS BEFORE	
OPERATING YOUR M-4	3
CONNECTION DIAGRAM	4
CONNECTION AND OPERATION	6
FRONT PANEL AND CONTROLS	7
SPECIFICATIONS	8
BLOCK DIAGRAM	9
CHARACTERISTICS DIAGRAM	9
SCHEMATIC DIAGRAM	10
TROUBLESHOOTING	11

FEATURES

- The voltage amplifying stage employs a cascade-connected differential two-stage circuit throughout.
The use of a Dual FET input and a new cascade bootstrap circuit in the first stage and a cascade-connection, current mirror and push-pull output in the pre-drive stage ensures a high degree of stability, low distortion and improved high-frequency characteristics.
- Two extremely large 15,000 μ F capacitors, two separate constant-voltage power supplies for the voltage amplifying stage, and the use of a pure copper plate earth line for ultra-low impedance guarantee greatly reduced inter-modulation distortion, improved separation and absolutely stable operation.
- In the driver and the power amplifier a three-stage emitter follower is paralleled with pure complementary OCL SEPP circuitry using high- f_T transistors. This accounts for wide bandwidth, high output and low distortion.
- **Other Features**
Except for the chemical capacitors in the power supply section, mylar and styrol capacitors are employed throughout. Layout of parts, wiring, earth line as well as many other aspects have been given due consideration.
The basic design ensures high reliability, while the ultimate aim has been the improvement of the overall audio characteristics.

Special Instructions for British-Standard Model IMPORTANT

THE WIRES IN THE MAINS LEAD ARE COLOURED IN ACCORDANCE WITH THE FOLLOWING CODE:

BLUE: NEUTRAL
BROWN: LIVE

As the colours of the wires in the mains lead of this apparatus may not correspond with the coloured markings identifying the terminals in your plug, proceed as follows. The wire which is coloured BLUE must be connected to the terminal which is marked with the letter N or coloured BLACK. The wire which is coloured BROWN must be connected to the terminal which is marked with the letter L or coloured RED.

M-4

CAUTION ; READ THIS BEFORE OPERATING YOUR M-4

1 PLACE OF INSTALLATION

Do not use the set in

- locations exposed to direct sunshine, such as near windows
- locations of high temperatures, such as near heaters
- locations of extremely low temperatures
- humid or dusty locations
- Since the M-4 is quite heavy 18.5 kg it should be placed on firm base.

2 WATER DAMAGE

If by accident the set has come into contact with water, immediately disconnect the power plug and contact your YAMAHA service store. Be careful not to place any container that holds liquid near the amplifier.

3 PROPER VENTILATION

Never cover the ventilation holes on top of the amplifier with any object. If proper ventilation is not ensured, the internal temperature of the set will rise unduly, which will cause improper operation and lead to damage.

4 CAREFUL HANDLING

Avoid using strong force when operating any of the switches and controls.

5 UNAUTHORIZED OPENING

Never open the case of the amplifier or touch any of the parts inside, as there is serious danger of electric shock.

If, by accident, some foreign matter has been dropped inside the set, immediately disconnect the power plug and contact your YAMAHA service store.

6 ADDITIONAL AC POWER RECEPTACLE (GENERAL EXPORT MODELS ONLY)

The additional AC power receptacle on the rear panel of the set is **UNSWITCHED** (not linked with the power switch) and has a maximum capacity of 100W. Before connecting another piece of equipment to this outlet, check its power consumption to ensure it does not exceed this limit.

7 MOVING THE SET

Before moving the amplifier, be sure to disconnect the power plug as well as all other connection cords.

8 POWER CORD

When disconnecting the power cord, always hold the plug itself and do not pull the cord.

When the set is not to be used for a long period of time, it is recommended to disconnect the power cord.

9 PLAYING RECORDS

Be sure to turn down the volume on the control amplifier before lifting or lowering the tone arm when playing records. Otherwise the transient noise may cause damage to the speakers.

10 MAKING CONNECTIONS

Always switch off the power before connecting or disconnecting the input cables.

11 CLEANING

Avoid wiping the case with liquids such as benzine or thinner, and do not use insecticide sprays or the like near the set. Always use a soft, dry cloth to wipe the set.

12 BEFORE REQUESTING SERVICE

Before calling in a service technician, please check the TROUBLESHOOTING chart in the last section of this manual to be sure there is no misoperation.

13 OWNER'S MANUAL

Please keep this Owner's Manual for future reference.

M-4

CONNECTION DIAGRAM

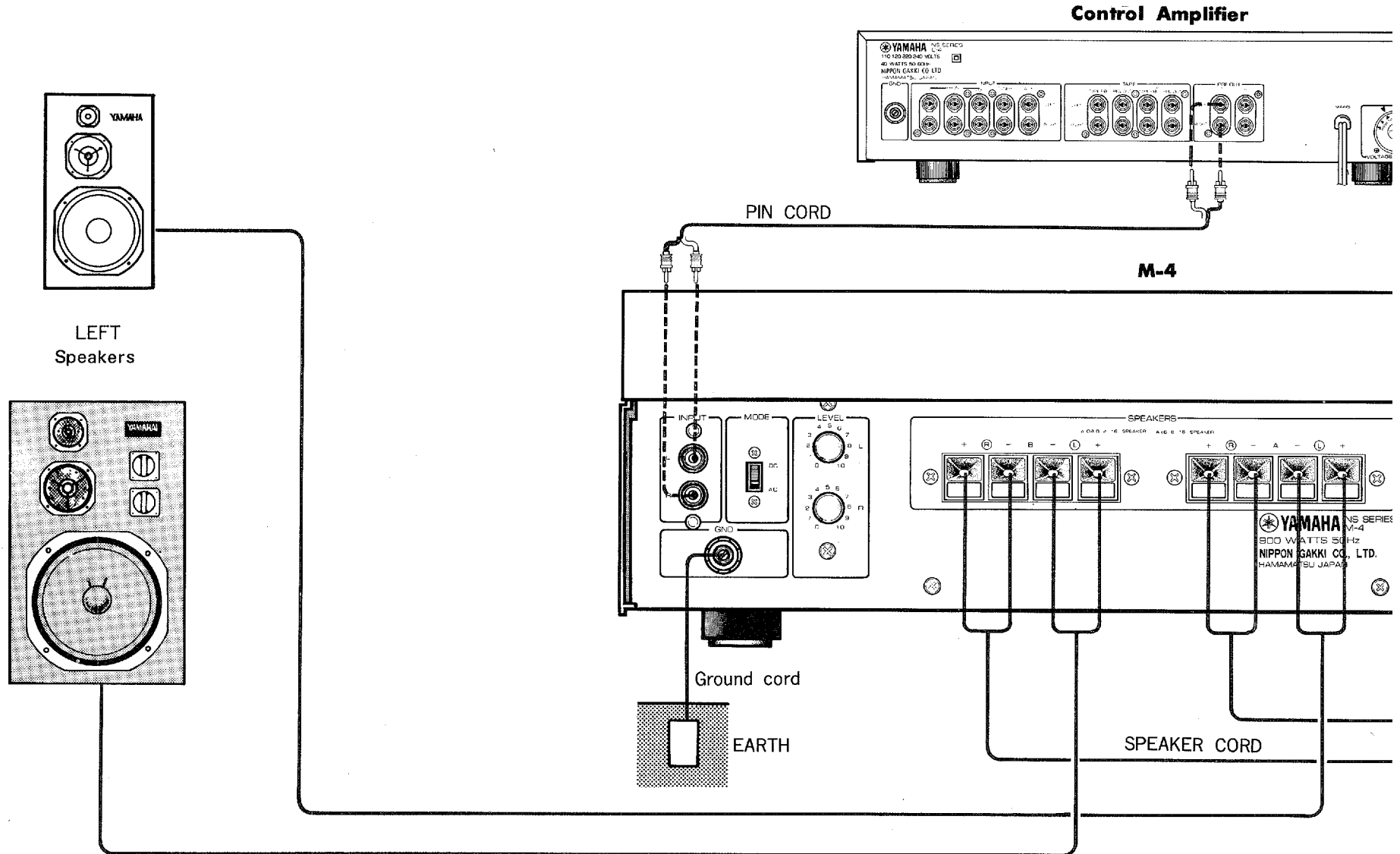

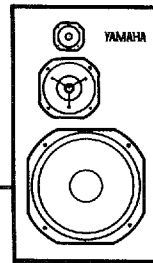
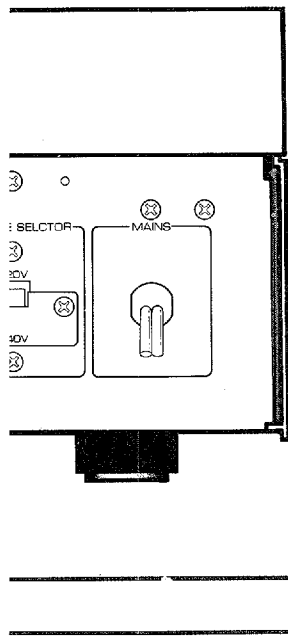

RIGHT
Speakers

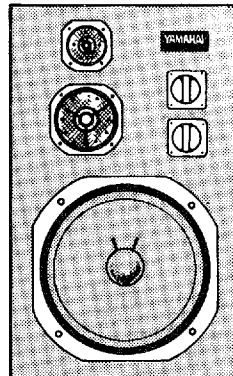

General Model

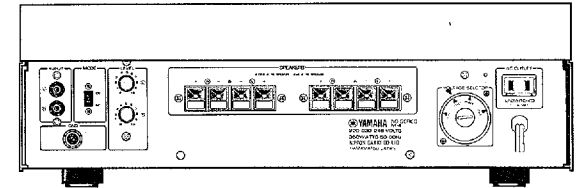

North European Model

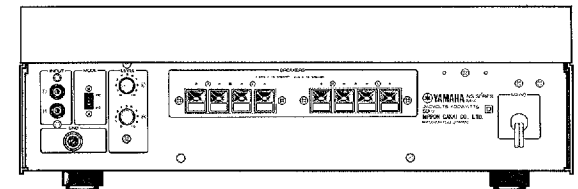

British/Australian Model

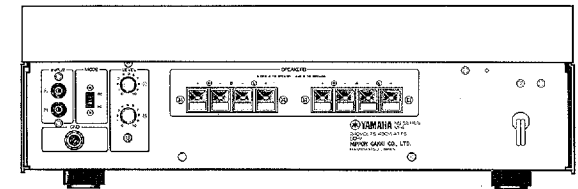

Voltage Selector

EUROPEAN

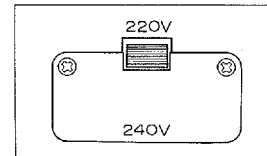

GENERAL

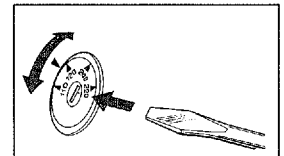

Setting positions are 220V/240V (European) and 110/120V/220/240V (General)

M-4

CONNECTION AND OPERATION

1. AC CONNECTION

- 1 As the rated power consumption of the M-4 is 900W (European model), do not connect it to an additional AC receptacle on some other piece of equipment, but plug it directly into a wall outlet.
- 2 Regardless of the position of the power switch, the additional AC power outlet on the rear panel of the M-4 provides AC power for a maximum consumption of 100W. (General Export models only)

2. SPEAKER CONNECTIONS

Use speakers with an impedance of $4\Omega\sim 16\Omega$ (General, European model) and $8\Omega\sim 16\Omega$ (the others) and connect them either to the A- or B-terminals on the rear panel. When using two sets of speakers at the A- and B-terminals simultaneously, be sure to use only speakers having an impedance of $8\Omega\sim 16\Omega$. (16 Ω for British, Australian, North European models)

Confirm that the polarities (+ & -) are correct and connect the cords of the left speaker system to the L-side terminals and the cords of the right speaker system to the R-side terminals.

Be careful to establish correct polarity because reversed connections to one speaker will lead to unnatural sound and poor bass reproduction.

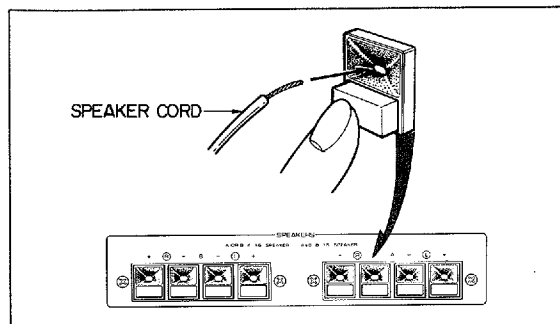

3. CONNECTION TO CONTROL AMPLIFIER

- Switch off the power to the control amplifier as well as to the power amplifier.
- Connect the output from the control amplifier to the INPUT terminals on the rear panel of the M-4, being careful to connect left to left and right to right channels.

LEVEL CONTROLS

- Level controls are provided on the rear panel to adjust the M-4 for use with any control amplifier.

The upper knob is for the left channel and the lower one for the right channel.

If the sound is distorted by using a control amplifier with a high output, lower the input sensitivity by turning these knobs counterclockwise.

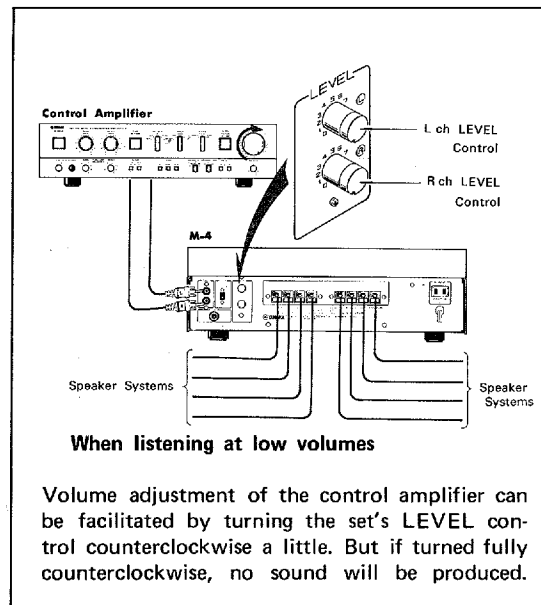

MODE SWITCH

- The M-4 has a flat frequency response down to DC, which will lead it to amplify even very low frequency noise such as caused by record warp and wow of the turntable. This can have adverse effects on the reproduction of the program material.

For this reason, the MODE switch has been provided which makes it possible to switch between "DC" and "AC" operation. It is recommended to use the amplifier in the "DC" mode unless the above adverse effects are noted.

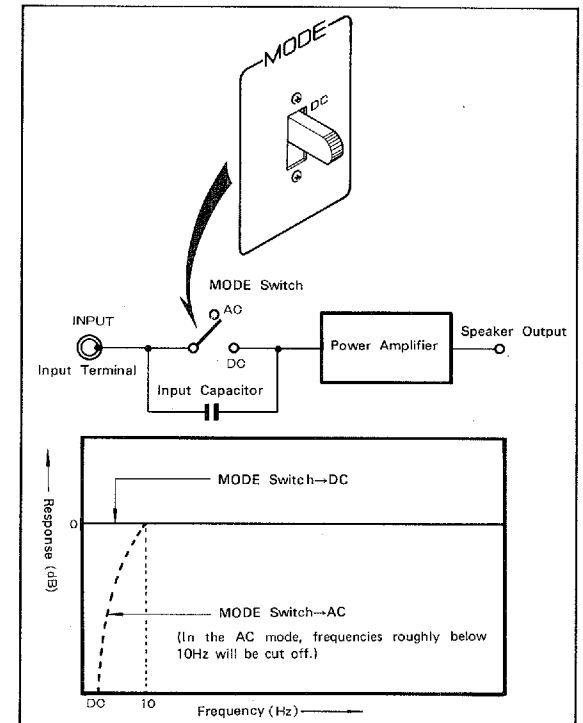

M-4

FRONT PANEL AND CONTROLS

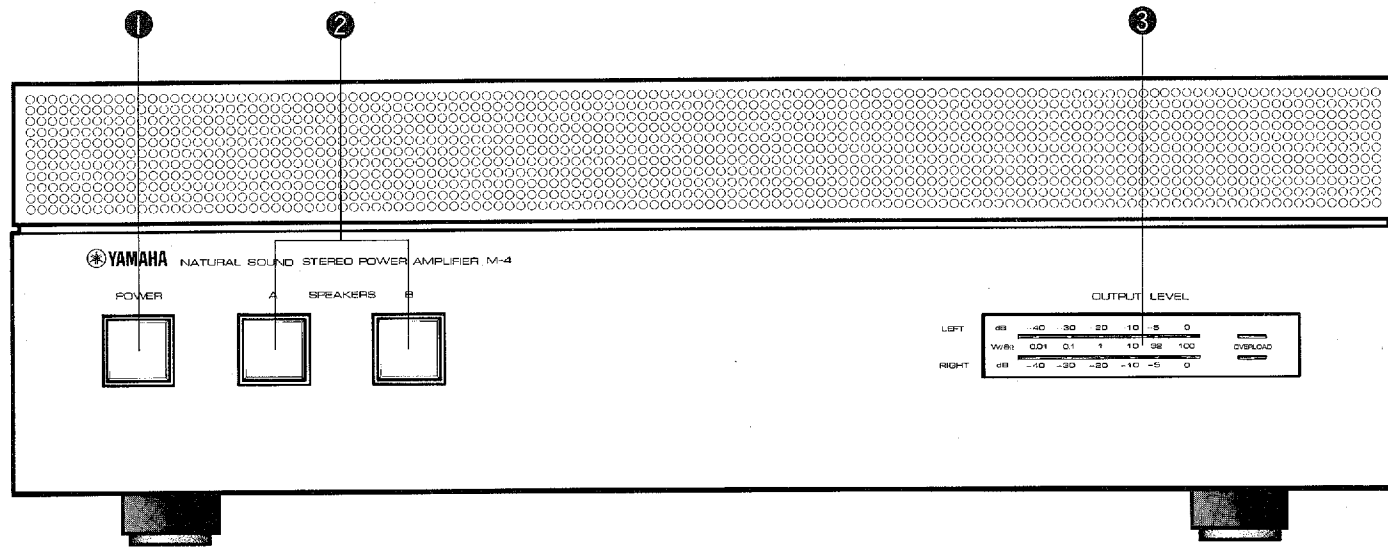

① POWER (switch)

When this button is depressed, power to the unit will be switched on and the switch will light up. When depressed again, power is turned off.

- 1 Due to the action of the muting relay, no sound will be heard for several seconds after switching on the power. This prevents any transient switching noises from reaching the speakers.
- 2 Be sure to turn down the VOLUME control on the control amplifier to minimum before turning on the POWER switch to guard the speakers against any sudden loud program sounds produced after the muting relay time.

② SPEAKERS (A and B)

These two push-button switches govern the two speaker terminals A and B. When depressed, the speaker set connected to the respective terminal will be connected and the switch will light up. Depressing the switch again will disconnect the speakers.

When using both terminals at the same time, refer to "Speaker Connections" (p. 6) regarding speaker impedance.

The SPEAKER switches should be turned off when changing the connection of the speaker cords, and they can be used in other cases, such as changing program sources etc., as well.

③ OUTPUT LEVEL (PEAK and OVERLOAD INDICATOR)

These peak indicators provide visual indication of the left and right output levels. They cover a range of 0.0032W to 100W (8Ω) (-45dB to 0dB).

Note: Also that the meters are calibrated accurately for output power into standard 8Ω speakers, but that corrections must be applied if speakers with different impedance are used.

For 4Ω speakers the readings should be multiplied by two (i.e., a reading of 50 watts indicates an output power of 100 watts), and for 16Ω speakers the reading should be divided by two (i.e., a reading of 50 watts is really only an output power of 25 watts).

Clipping (at about 1% THD) is indicated for the left and right outputs separately by the OVERLOAD indicators. When these light up, turn down the input level by using the LEVEL controls on

M-4

SPECIFICATIONS

Rated Output Power	
120W + 120W (8Ω, 20Hz~20kHz)	0.005% T·H·D) (R, E)
170W + 170W (4Ω, 20Hz~20kHz)	0.01% T·H·D) (R, E)
100W + 100W (8Ω, 20Hz~20kHz)	0.005% T·H·D) (G, B, A)
Power Band Width	
10Hz~100kHz	(8Ω, 60W, 0.02% T·H·D)
	(R, E)
	(8Ω, 50W, 0.02% T·H·D)
	(G, B, A)
Damping Factor	
200 (8Ω, 1kHz)	
100 (4Ω, 1kHz)	
Input Sensitivity/Impedance	
1V (100W/8Ω)/25kΩ, 500pF	
Frequency Response	
MODE "DC"	8Ω, 60W (R,E) · 50W (G,B,A)
10Hz	: 0dB
1kHz	: 0dB
100kHz	: -0.7±0.5dB
MODE "DC"	8Ω, 60W (R,E) · 50W (G,B,A)
10Hz	: -1.5±0.5dB
1kHz	: 0dB
100kHz	: -0.7±0.5dB
Signal-to-Noise Ratio	
118dB (IHF-A Network, RL=8Ω, 1kΩ terminated at Input terminal)	
Residual Noise	
32μV (8Ω, IHF-A Network, Input VR min.)	

Harmonic Distortion	
Less than 0.005%	
	(8Ω, 10Hz~20kHz, 60W)
	(R, E)
	(8Ω, 10Hz~20kHz, 50W)
	(G, B, A)
Less than 0.02%	
	(8Ω, 100kHz, 60W) (R, E)
	(8Ω, 100kHz, 50W) (G, B, A)
IM Distortion (EIAJ, IHF, DIN)	
Less than 0.002%	
	(8Ω, 50Hz:7kHz=4:1, 60W)
	(R, E)
	(8Ω, 50Hz:7kHz=4:1, 50W)
	(G, B, A)
Channel Separation (L → R, R → L)	
90dB (8Ω, 1kHz, 60W) (R, E)	
(8Ω, 1kHz, 50W) (G, B, A)	
70dB (8Ω, 20kHz, 60W) (R, E)	
(8Ω, 20kHz, 50W) (G, B, A)	
Filter Characteristics	
MODE "AC"	fc = 6.4Hz, -6dB/oct (Low Cut Filter)
Peak Indicator	
Indicator Point	: 0dB=100W (8Ω, 1kHz)
Indicator Level	: 0dB~-45dB (-5dB step)
Attack Time	: 100μ sec.
Release Time	: 1.2 sec. (-45dB ↔ 0dB)
Overload Indicator	
Indicator Level	: 1% Distortion
	(8Ω, 10Hz~20kHz)
Number of Semiconductors Used	
77 (Transistors)	
4 (Dual Transistors)	

3 (ICs)	
2 (Dual FETs)	
32 (Diodes), 2 (Dual Diodes)	
2 (Bridged Diodes)	
6 (Zener Diodes)	
24 (Green LEDs)	
4 (Red LEDs)	
Rated Voltage	
E	: 220/240V AC, 60Hz
R	: 110/120V/220/240V AC, 50/60Hz
G	: 220V AC, 50Hz
B, A	: 240V AC, 50Hz
Rated Power Consumption	
R	: 350W
B	: 500W
G, A	: 450W
E	: 900W
AC Outlet	
100W Unswitched x 1	
(R only)	
Dimensions	
W: 435, H: 145.5, D: 374.5 mm	
(17-1/8") x (5-3/4") x (14-3/4")	
Weight	
18.5kg (40.8 lbs)	
Specifications subject to change without notice.	
R: GENERAL	A: AUSTRALIAN
E: EUROPEAN,	G: NORTH EUROPEAN,
B: BRITISH	

M-4

BLOCK DIAGRAM/CHARACTERISTIC DIAGRAM

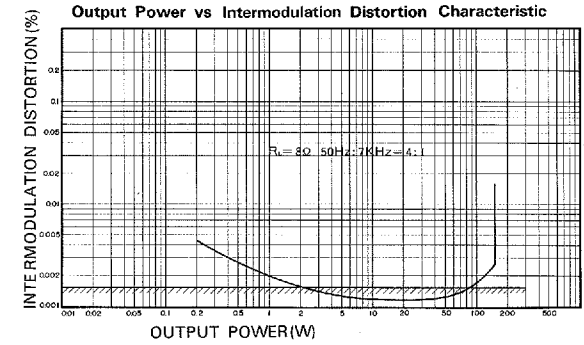
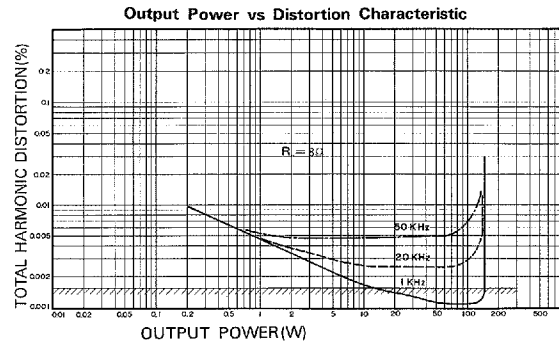
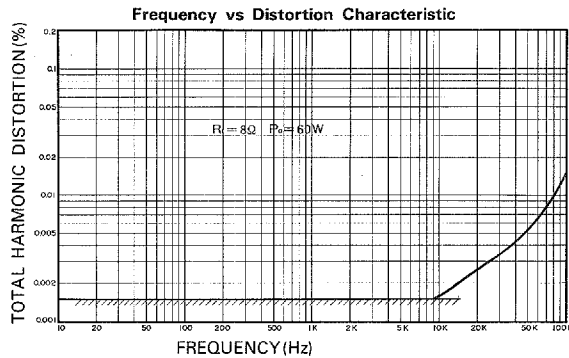
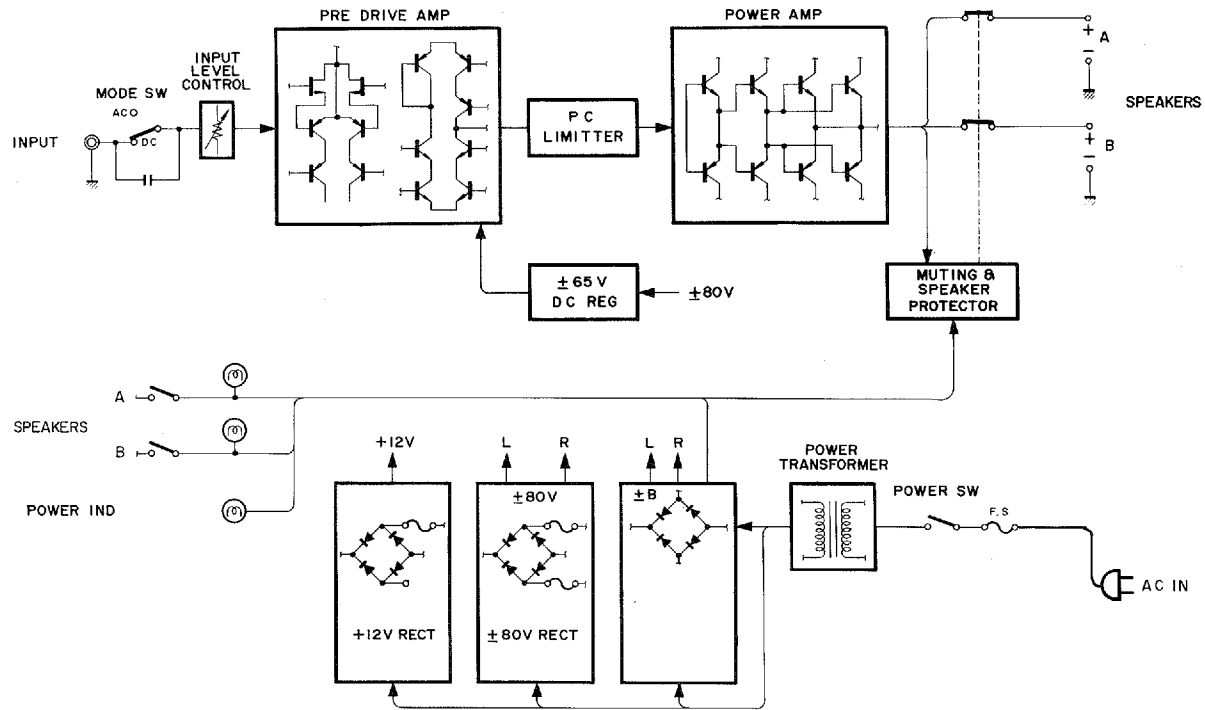

M-4

TROUBLESHOOTING

Symptom	Cause	Remedy
Power will not turn on although POWER switch is ON.	Power cord plug is not firmly inserted into AC outlet.	Re-insert power plug into AC outlet in a firm manner.
	Power does not turn on when power plug is inserted into AC outlet.	Contact an audio serviceman at your nearest YAMAHA dealer.
No sound produced from the right and left speakers, or either the right, or left speaker.	Insufficient connection between control amplifier and power amplifier, or between power amplifier and speakers.	Check and confirm connection, or operation.
	BALANCE control of the control amplifier has deviated either to the right, or left side.	Properly re-adjust BALANCE control of control amplifier.
	LEVEL control turned down too much. (Turned too far counterclockwise.)	Turn LEVEL control clockwise.
Sounds suddenly cease to come out during PLAY.	Speaker's protective circuit is working because a DC potential not less than 2.4V has generated at the speaker's output terminal.	When the potential of the power amplifier becomes zero, the relay will be actuated, causing the circuit to be connected. Turn off the POWER switch of the power amplifier. Wait a little while and turn it on again.
	Abnormality inside the circuit.	Contact an audio serviceman at your nearest YAMAHA dealer.
Unnatural reproduced sounds with poor bass and instable stereo image.	The phases (+ and -) of the power amplifier not matching those of the speakers.	After matching the phases properly, re-connect.
Sufficient volume not obtained when VOLUME control of control amplifier is turned up.	Input LEVEL control is turned counterclockwise.	Adjust to proper volume by turning input LEVEL control clockwise.
Loud humming generates during program audition.	Insufficient contact of pin plug.	Re-insert pin plug in firm manner.
	Earth line of turntable not connected to GND terminal of control amplifier.	Connect earth line to GND terminal of control amplifier.

SINCE 1887



YAMAHA

NIPPON GAKKI CO., LTD. HAMAMATSU, JAPAN

